

www.tarranbikes.com
service@Tarranbikes.com



reddot winner 2025
bicycle design



TARRAN T1 Pro

Family Cargo Bike
Made Smarter

▶ @tarranbikes

📷 @tarranbikes

👤 r/TarranBikes

📘 @tarranbikes & tarranofficialgroup



Complied with DIN 79010, EN 15194, ROHS, certified by TÜV Rheinland.

Pushing Support

Balance support for easier pushing when carrying heavy cargo or walking uphill

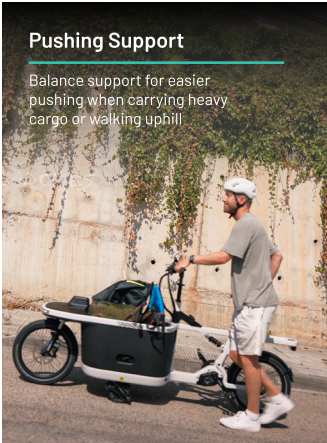

E-kickstand

Click and lift e-kickstand, effortless parking even when heavily loaded



Riding Support

Click to deploy when stopping anywhere during the ride. No need to step off or struggle with balance

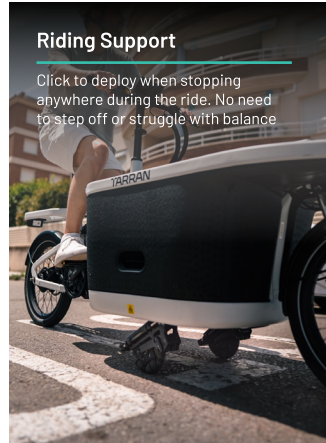

Down to Earth, Elevate Your Ride

Proprietary Dynamic Dualdrive™
Landing Gear System

No more worry about tipping over: Landing Gear system with suspension and adaptive algorithms, brings unprecedented stability.

Smart Control System

Featuring TARRANOS and TARRAN App, the smart control system integrates cameras, radar, lighting and more, interact with you easily on the 5.2-inch Retina Touchscreen to ensure seamless and safe riding.

TARRAN OS™ and TARRAN App

EV-grade intelligent control experience



Smart Lighting and Turn Signals



Integrated Dash Cam



Road Detection System
Alerts with handlebar vibration and notice on screen

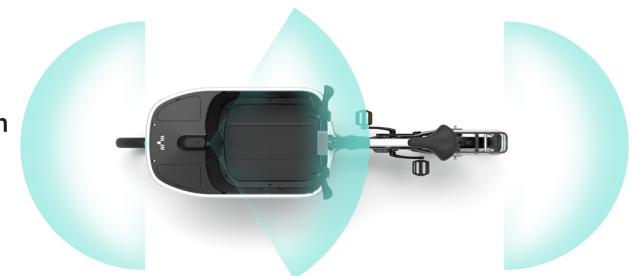

Smart Anti-theft

Peace of mind in every leave behind. With the TARRAN App, integrated cameras and sensors connected, T1 Pro is always protected.

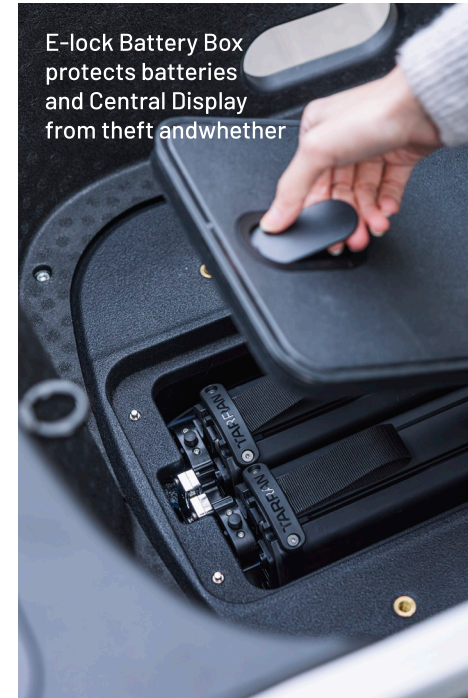

E-lock Battery Box protects batteries and Central Display from theft and whether

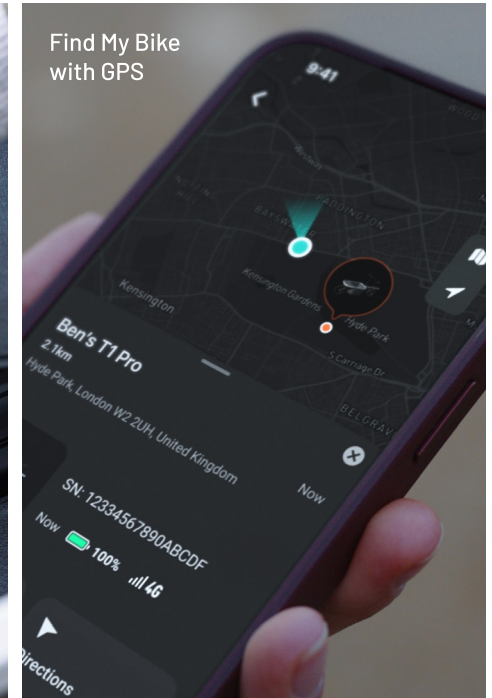

Find My Bike with GPS

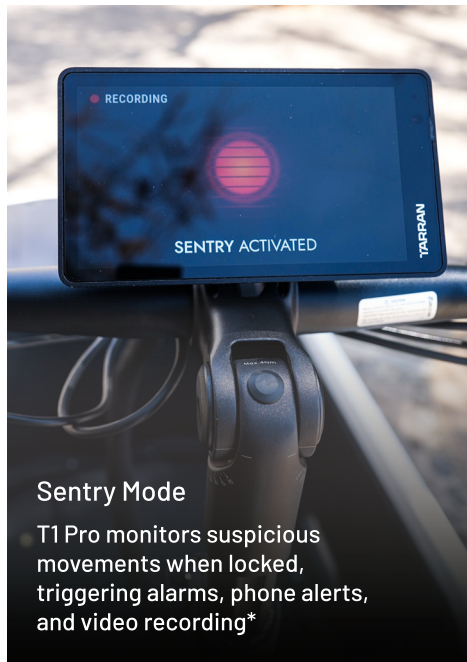

Sentry Mode

T1 Pro monitors suspicious movements when locked, triggering alarms, phone alerts, and video recording*

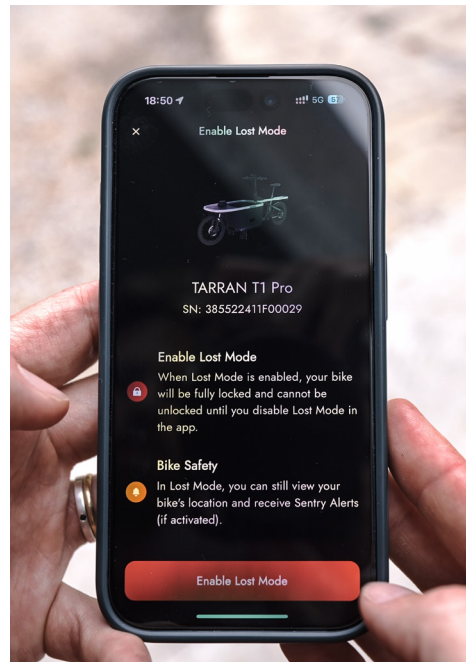

Keyless Entry: NFC, Phone Key and Walk-away Locking

*Camera activation requires user consent. All images/videos are stored locally by default. Our personal data policy is GDPR compliant.

67.5°

Max. Steering Angle

100 Nm

Max. Motor Torque

1.4 kWh , 200 km

Max. Battery capacity (with dual batteries)

2264 mm

Length

220 Kg*

Max. Load

*Including the bike, rider and cargo.

3 Euroboxes

or equivalent volume of cargo

Up to

2 Kids

with extra gear

**We love it
when you say
"Let's take one
more ride."**

Compact and mighty design with flagship maneuverability, comfortable for both riders and passengers.



1. 100 Nm Mid-Drive Motor: Power meets precision. (40hz Speed Sensor/Walk Assit/Slope Hold Assist)

2. Dual Battery System: Go up to 100km on a single charge. Opt for dual battery setup to ride even further.

3. Reliable Dual-cable Steering: Class-leading maneuverability for effortless tight-space navigation with smooth turns and precise pivot control.

We work with industry leaders,
but your after-sales service

starts and ends with us.

TARRAN customer support team responds within
1 working day. We arrange spare parts shipping
within 1 workday.



Ergon GP10 Handgrip

5-year warranty
on the frame

Suntour Front Fork

2-year warranty
on other components*

Fastace Full Suspension

TRP Disc Brake

Gates Carbon Drive CDX

Enviolo Heavy Duty Hub

*Against material or manufacturing
defects under normal use.

Monthly checks are good, Daily auto-diagnosis is better.

Replace, Don't Repair.

Nearly 50% of the parts can be directly replaced by users at home. Remaining issues can be resolved at a dealer store within 1 workday.

OBD (On-Board Diagnostics) System quickly detects and pinpoints faulty electronic components every time the bike is powered on. Monitor up to 8 on-board electronic components.



Check how easy it is to replace faulty parts on T1Pro

See what's running. Choose how it runs.

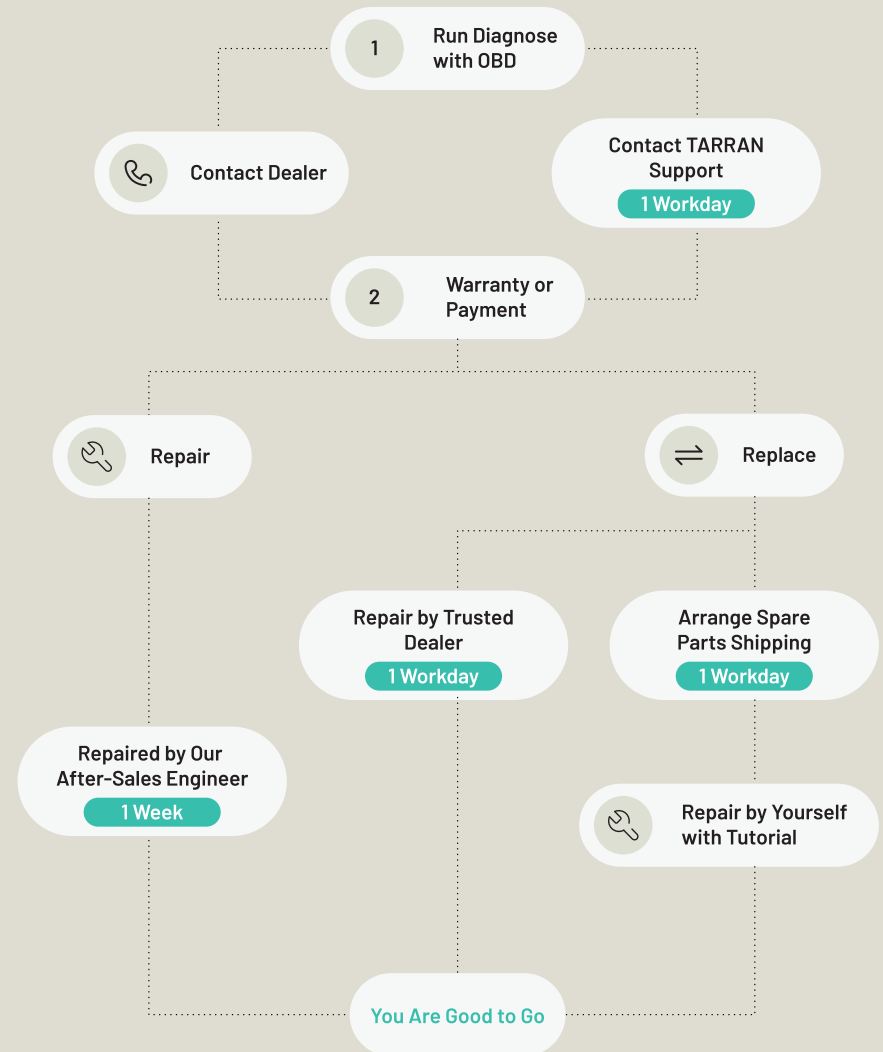

Color



Stardust
Silver & Black



Beige Grey

Accessories



Child Seat with 5-Point
Safety Harness

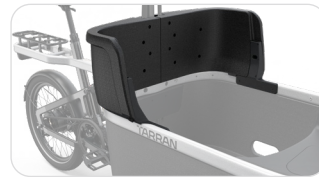

Protective Safety
Collar



Front Storage
Organizer



Quick Release
Rain Cover



MIK HD Cargo
Rack



All-weather Bike
Cover

Electronics

Motor	Mid-drive Motor, 100Nm. Rated continuous output, 250W. Maximum power, 750W
Battery	Internal 708Wh, removable, dual battery available
Display	5.2-inch Retina TouchScreen with TarranOS
Headlight	Spanninga, 80Lux, x2, with high and low beam
Tail Light	Sate-lite, M15
Connectivity	LTE Module*, 5 GHz Wi-fi, Bluetooth 5.1

*Comes with 1-year of free data. Subscription plan required to use LTE features. Contact TARRAN support team for more details.

Components

Front fork	Suntour SF22 MOBIE A32 CG0 20", 50mm, 1 1/8", 15x100mm
Rear Suspension	Fastace 165mm, Rebound adj 12 clicks
Brake System	TRP C2.3, Reach adjustable, ON/OFF Switch TRP R180S01E 180mm Rotor, 2.3mm Thickness, 6-bolt
Chain	Gates Carbon Drive CDX
Tire	Schwalbe, PICK-UP Perf, Super Defense, TwinSkin 55-406 B/B+RT HS609 ADDIX E 2x67EPI 33B
Front hub	NECO sealed bearing, 15*100mm thru-axle, 6-bolt, 36h
Gear hub	Enviolo Heavy Duty, Disc, 36h

Performance

Max. assist speed	25 km/h
Range*	Up to 100km (Single Battery) Up to 200km (Dual battery)
<small>(*Data from unloaded Eco mode testing; actual performance may vary depending on real-world conditions and usage)</small>	
Bike weight (without accessories)	65 kg
Max. total load (bike, rider, load)	220 kg
Max. rider weight	100 kg
Max. passenger height	126 cm
Rider Height Range*	155-195 cm

*Achieved through two-stage seat tube

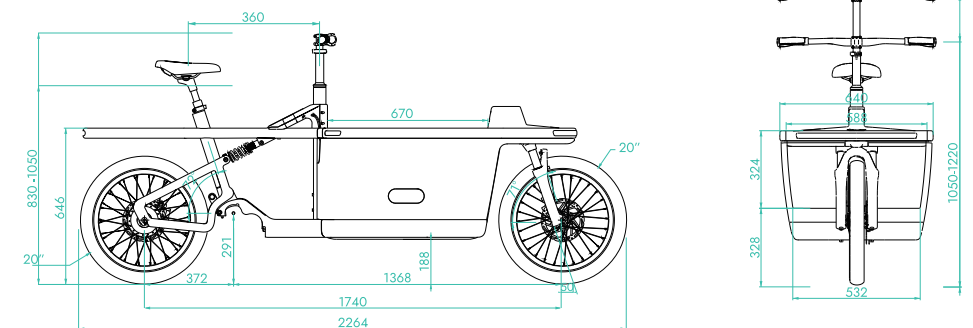

For more details, please visit <https://tarranbikes.com/pages/tarran-t1-pro>